



NIKO Overhead Conveyor Systems

FOR PAINTING LINES
Case study evaluation

smak
Industrial Handling
Solutions

SmakHandling.com

1.844.841.2288



www.niko.eu.com



Light Cranes Conveyor systems Monorails
 Painting Lines Suspension Tool System

We have over 50 years experience in producing high quality sliding door fittings and overhead conveyor systems at the right price, with close contact to suppliers and customers and continuous product development. NIKO Overhead Conveyor System will provide you with the advantage you need for your painting line.

Our guiding principle is:

NIKO...Quality in Motion

AUSTRIA
NIKO Vertriebs GmbH
 Hainfelder Straße 48
 A - 2560 Berndorf
 Tel. 0043 2672-21201
 Fax 0043 2672-21201-13
 office.at@niko.eu.com
www.niko.world

CHINA-NIKO TRADING (SHANGHAI) Co., Ltd
 Room 605, Building #13, No.354
 Linghe Road, Pudong District,
 P.R.China - 200120 Shanghai
 Tel. 0086 139 1814 5645
 info.cn@niko.eu.com

GERMANY
NIKO Technik GmbH
 Robert-Bosch-Str. 14
 DE - 42489 Wülfrath
 Tel. 0049 (0) 2058 9093603
 Fax 0049 (0) 2058 9093604
 office.de@niko.eu.com

GREECE
Helm Hellas S.A.
 82nd Km Athens-Korinthos
 P.O. Box 209
 GR - 201 00 KORINTHOS
 Tel. 0030 27410 76800
 Fax 0030 27410 25368
 info@niko.eu.com

POLAND
NIKO Polska
 Wojska Polskiego 65A
 PL - Wielun 98-300
 Tel. 0048 504 00 35 56
 info.pl@niko.eu.com

- NIKO Locations
- NIKO Representatives

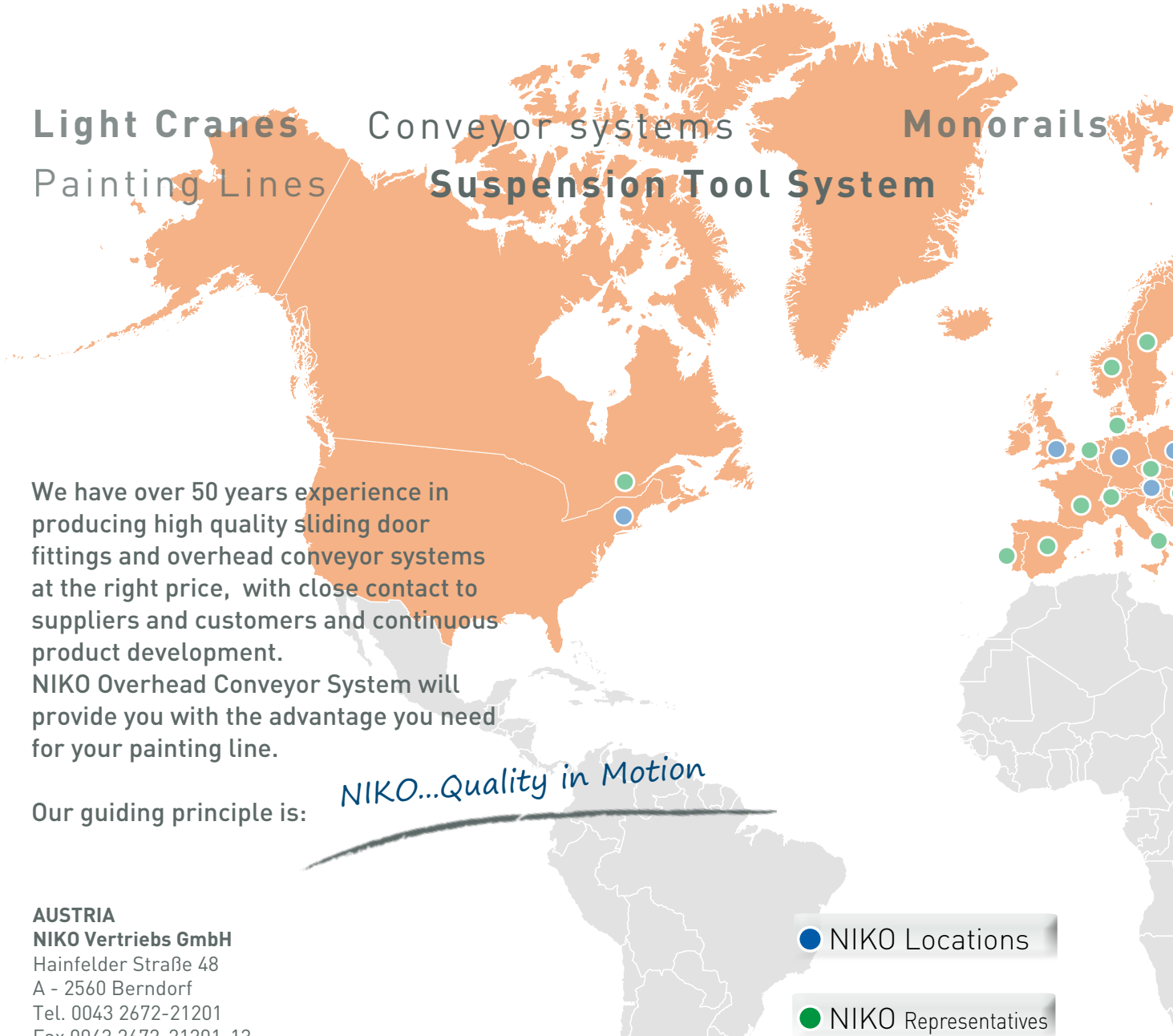



Global LOCATIONS & HEAD OFFICE

Power Chain Conveyors **Manual Conveyor Systems**
Jib Cranes **Festoon Systems & Cable trolleys**
Conductor bars **Fall Arrest Systems**

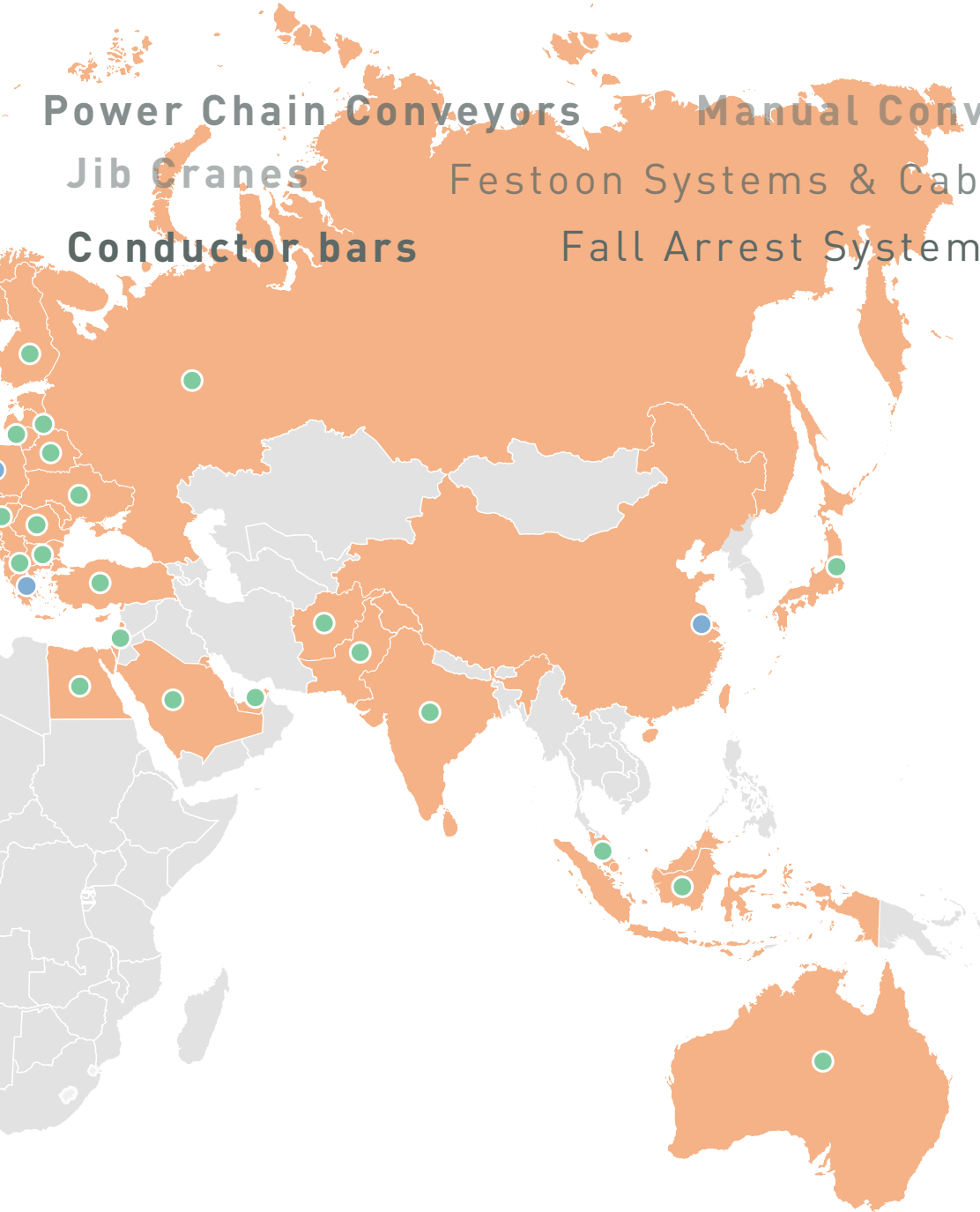

UNITED KINGDOM

NIKO Ltd
Airfield Park Business Park
Welsh Road East, Southam
Warwickshire, CV47 1NE
Tel. 0044 (0) 1926 813111
Fax 0044 (0) 1926 815599
Sales@niko.co.uk
www.niko.co.uk

CANADA - NIKO Crane Canada

615, rue du Nickel
Québec (Québec) G2N 0J9
Tel. 418 841.2287
info@smakdesign.ca
www.smakmanutention.com

USA Light Crane Systems- NIKORAIL

8000 Joliet Rd.
McCook, IL 60525
Toll Free 888.352.1213
Tel. 001 708-352-1213
sales@dhsicrane.com
www.nikorail.com

USA-NikoTrack LLC

210 Century Drive
Bristol, CT 06010
Tel. 001 860-845-8179
Fax 001 860-584-8612
info@nikotrack.com
www.nikotrack.com







Why buy a NIKO conveyor system?

BENEFITS OF NIKO overhead conveyor systems for painting lines over other type of Conveyors

NIKO Conveyor system

Less floor space required

Niko Overhead Conveyor requires some floor-based support structures but this can be strategically placed at facility edges and corners to minimize their footprint. Monorails run on tracks installed directly into the ceiling and, therefore leave no footprint on the floor at all.

Avoid any re-paint procedure

Easy handling loadbars moved by hand, no contact with the painted product. Employee transfers the load hanged on loadbars and drives them throught the conveyor line. The worker touch the product in the loading zone and again after the whole process is finished.

Less safety hazards for workers and equipment.

Niko Overhead Conveyor reduce physical labor, provide easy moving solution for increased efficiency and reduce injuries caused by improper lifting and falling materials

Easier manipulation of products even after exit of products from drying/curing process.

Varied of products (in size, type and weight) and bigger amount of products to be suspended on loadbar(s) at the same time, thus increase productivity.

Options of overhead parking zones for products storage before proceeding to any other process.

Less workers needed to operate an overhead conveyor system compared to forklift systems thus increased productivity and reduce cost compared to Cart system.

Multi directional options without having to occupy additional workers.

Applicable in limited spaces.

Painting line with forklifts

Systems with forklifts create many facility limitations. Bulky ride-on movers generate clutter and restrict floor space because they require wide pathways and intersections to maneuver. Even when they are not in operation, forklifts and pallets with product (near to each process) and ride-on movers take up a large amount of space on the floor and get in the way of the production.

On the contrary, on systems with forklifts, products after painting must be transferred and most of the time are touching each other and paint gets skrat-ched. When employee moves parts from powder paint to oven, most of the time the product get in touch with his body. Products get in contact and might need to be repainted meaning additional cost

Floor-movers can impose safety hazards for workers and equipment.

Forklift operators must be trained and certified to operate the forklifts.



Niko power chain conveyor

Niko Systems occupy less space.

Ovens can be build smaller thus save money on equipment, on energy fuels and no big heat lose.

Easier handling of loading and unloading zones since they are free of chain.

With Niko System the customer has the option to create parking zones in different areas like masking or inspection areas.

Niko System costs less.

Easily modified when a customer needs to make an extension.

Safe.

When the system is running you can touch the track without danger.

NIKO enclosed track profile ensures that the bearings are not exposed to the environment therefore cause damage to trolley.



In Continuous Running Automatic Power Chain Conveyors the doors remain always open and that results to serious heat lose and cost increase.



In Continuous Running Automatic Power Chain Conveyors it is difficult to load/unload products since the system is in continuous movement. Furthermore, it is not possible to make parking zones to load/unload products or buffer zones to mask the technological holes on products before painting and after painting.

NIKO Track Profiles

Our wide range of 6 Track profile sizes can accommodate loads up to 2.000 kg. The NIKO enclosed track tapered design allows correct alignment of the trolleys and reduces the possibility of dust build up. This ensures the smooth running of the trolleys and the long life of the conveyor system. NIKO conveyors require only 1-4% force of the weight being lifted in order to operate. For use in special environments we can also offer NIKO tracks & components in stainless steel grade 304 and 316.

NIKO Profile No.	Dimensions			
	h (mm)	b (mm)	d (mm)	s (mm)
21.000	28	30	8	1,75
23.000	35,00	40,00	11,00	2,75
24.000	43,50	48,50	15,00	3,20
25.000	60,00	65,00	18,00	3,60
26.000	75,00	80,00	22,00	4,50
27.000	110,00	90,00	25,00	6,50

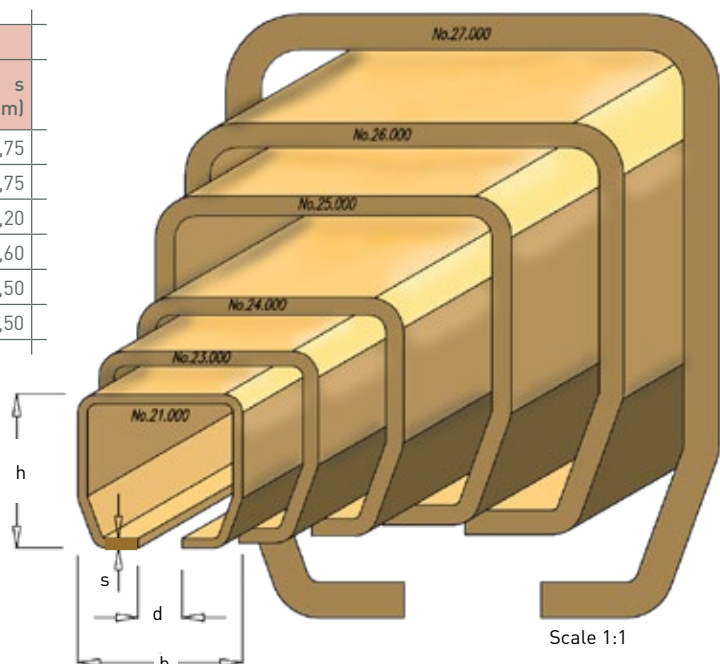



PAINTING LINE - EXAMPLE 1

NIKO power chain conveyor system with swivel switches

Key advantages:



High productivity achieved utilising mechanically automatic switches



The best value for money solution



Power side transfer through the painting booth



Optimal space utilization inside the oven



Spacious parking areas for the flight bars

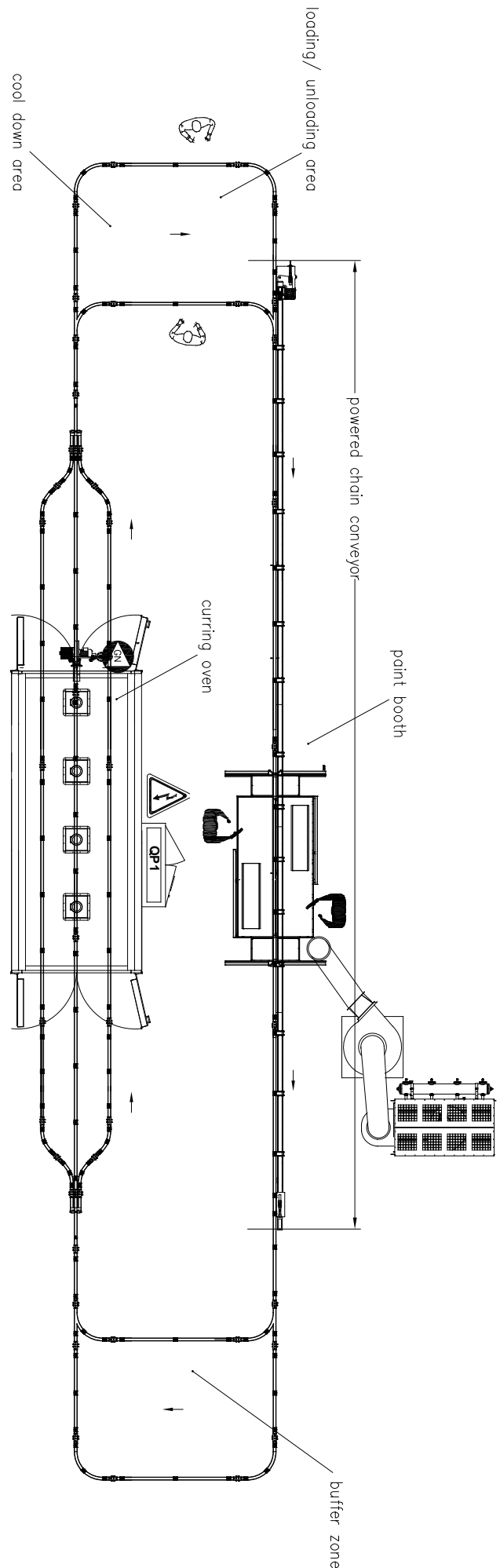

NIKO PAINTING LINES - EXAMPLES

PAINTING LINE-EXAMPLE 2

NIKO power chain conveyor

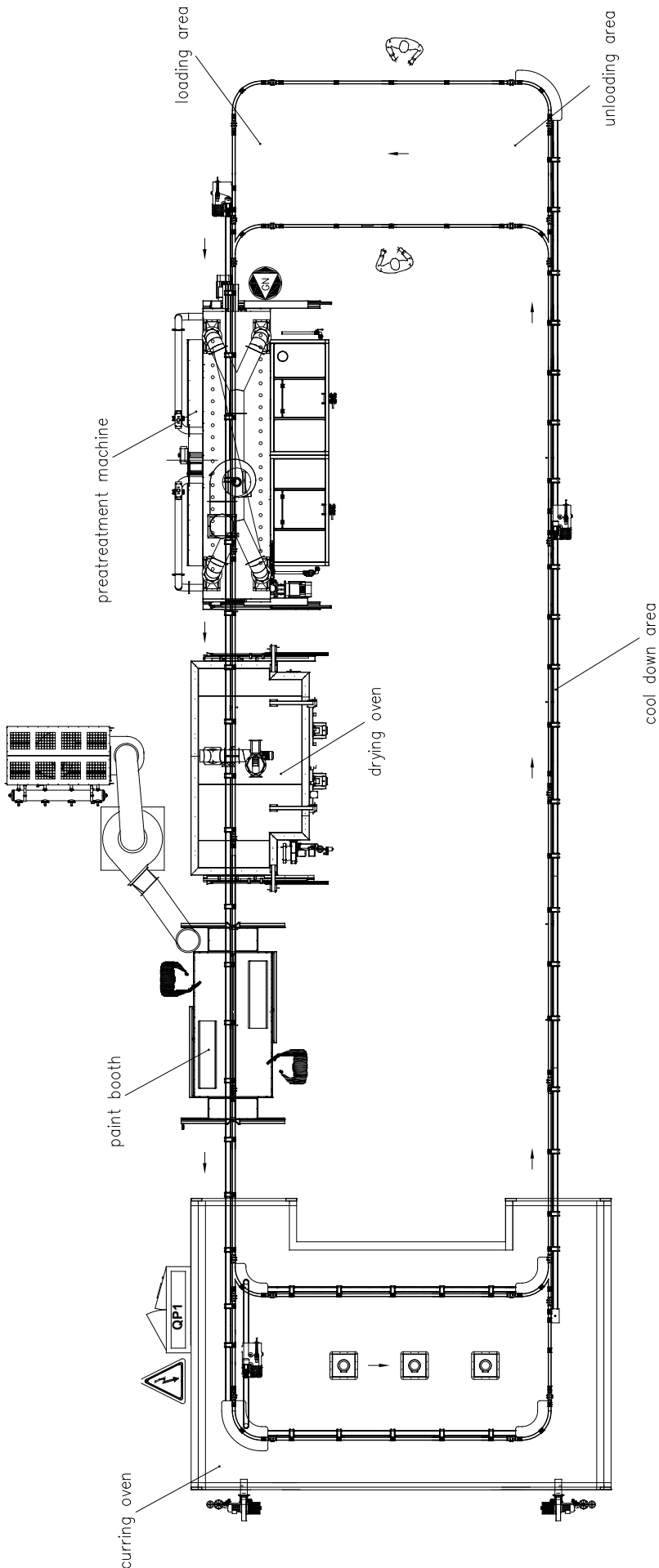

Key advantages:



Less labor cost



Automatic flight bar transportation in consecutive stages of production process



Increased production in the curing oven (parallel movement of flight bars into oven)



Power side transfer except loading/unloading area



PAINTING LINE - EXAMPLE 3

Completely powered NIKO conveyor system

Key advantages:



Completely powered system with power chain conveyor and batch shuttle with power driven trolley



High productivity



Less labor cost



Automatic loading/unloading of flight bars in batch shuttle



Automatic connection between batch shuttle lines and conveyor system

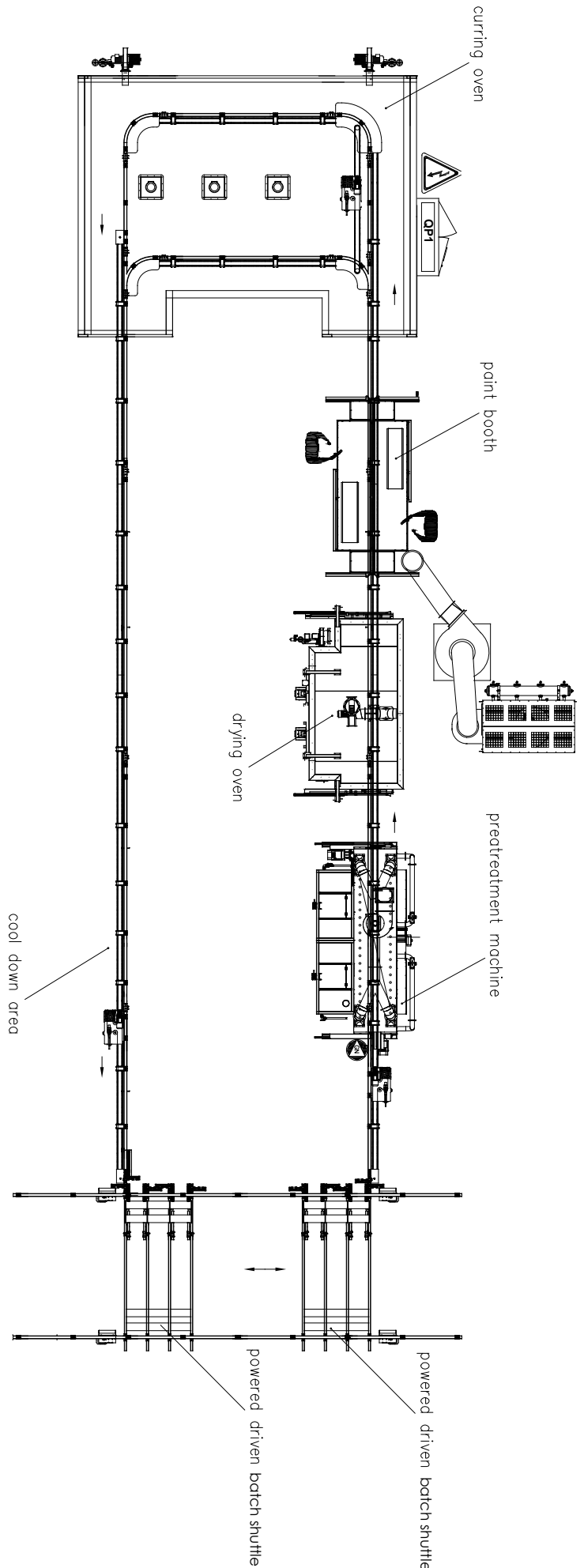

NIKO PAINTING LINES - EXAMPLES

NIKO power chain conveyor with pneumatic turntables

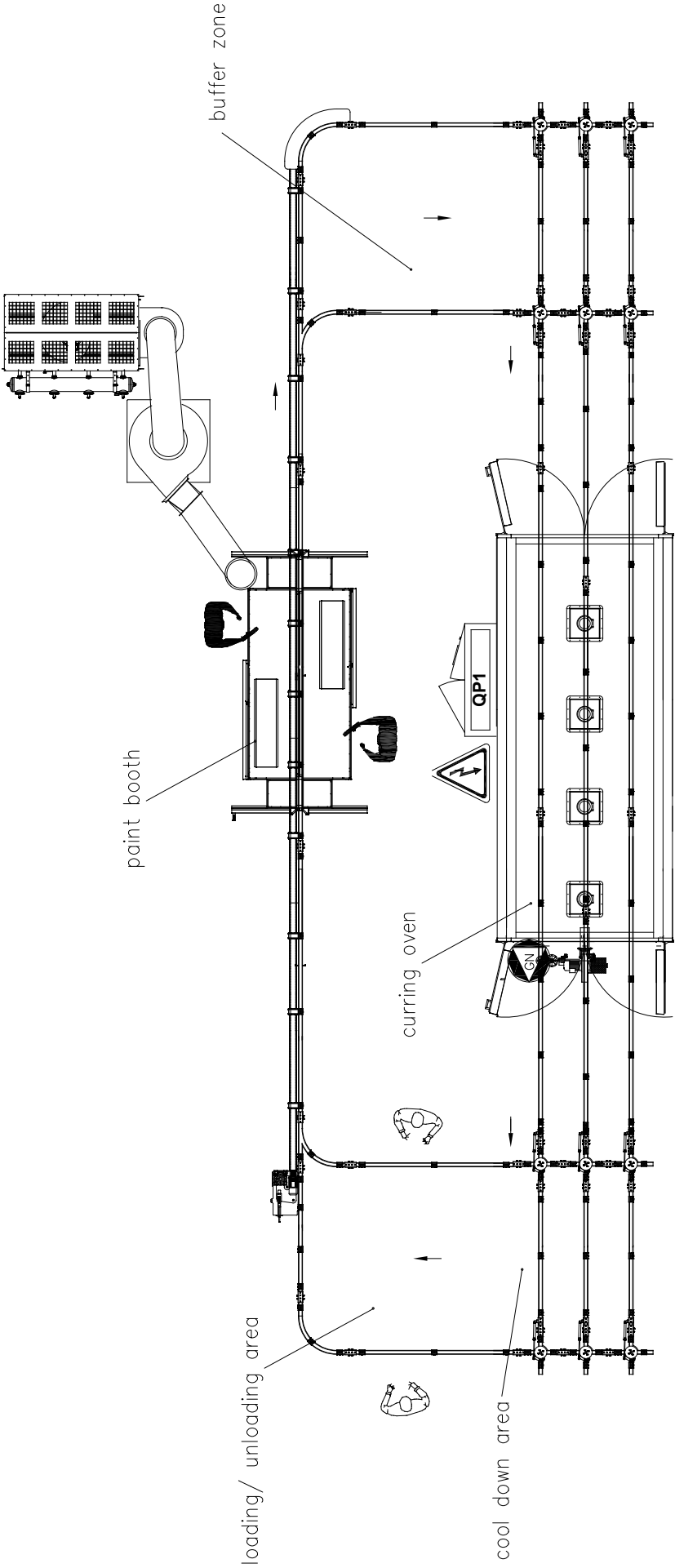

Key advantages:



Minimum space requirements utilizing pneumatic turntables



Power side transfer through the paint booth



Value for money solution



Optimal space utilization inside the oven



PAINTING LINE - EXAMPLE 5

NIKO conveyor systems with batch shuttle and power chain in the painting booth

Key advantages:



Low cost solution



Power side transfer through the paint booth



Optimal space utilization inside the oven



Easier operation in pushing/pulling loads



Ergonomically designed batch shuttle

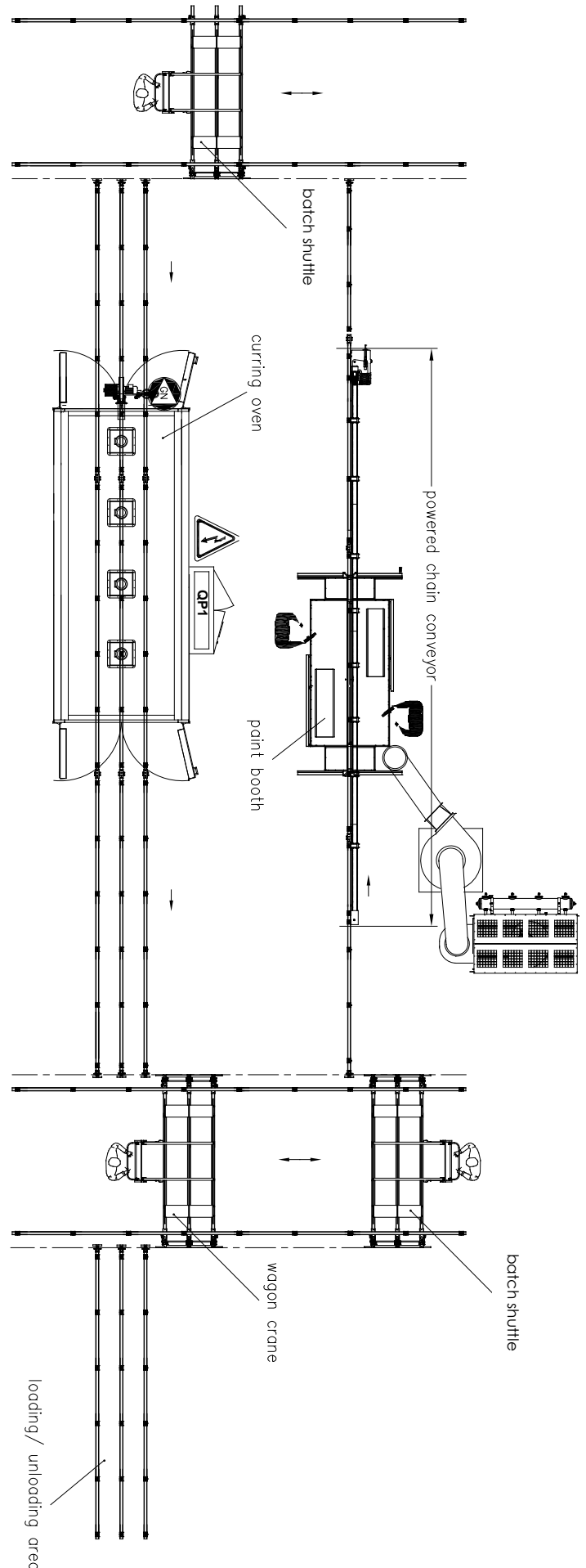

NIKO PAINTING LINES - EXAMPLES

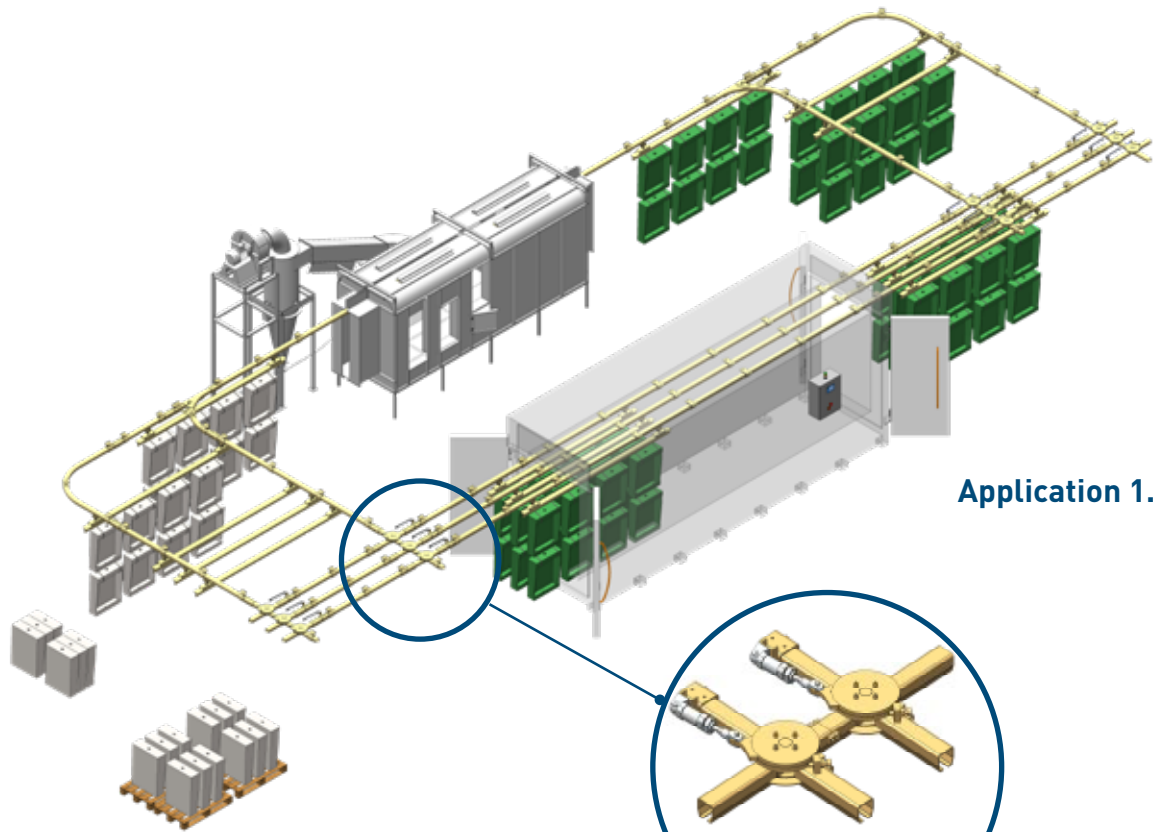

Application 1.

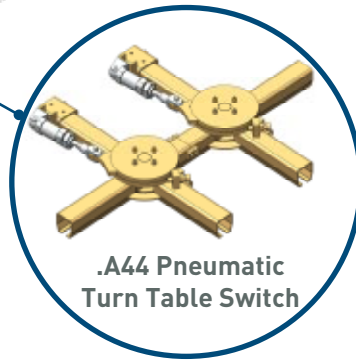

.A44 Pneumatic
Turn Table Switch

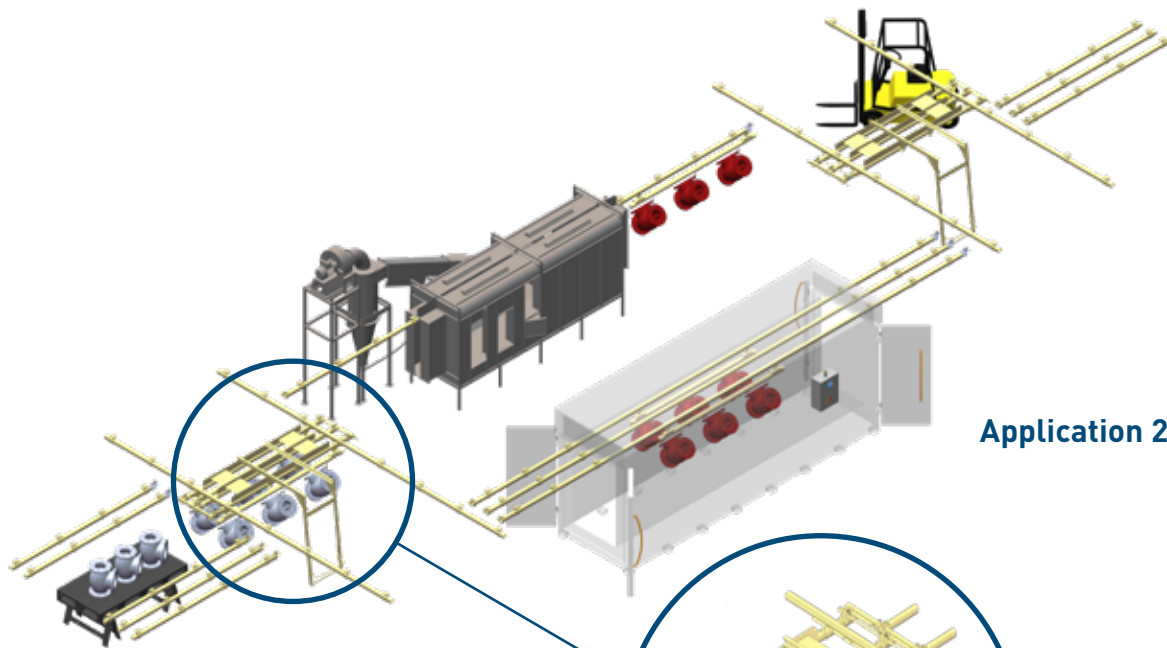

Application 2.

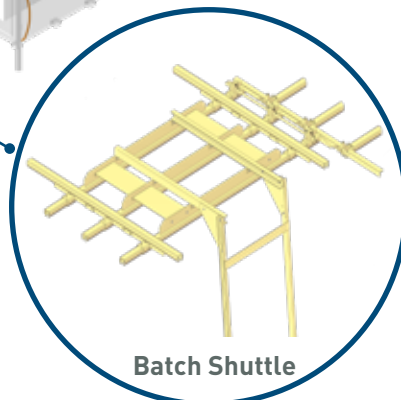

Batch Shuttle

NIKO PAINTING LINES - 3D APPLICATIONS



PAINTING LINE - 3D APPLICATIONS
NIKO Power Chain Conveyors

NIKO PAINTING LINES - 3D APPLICATIONS

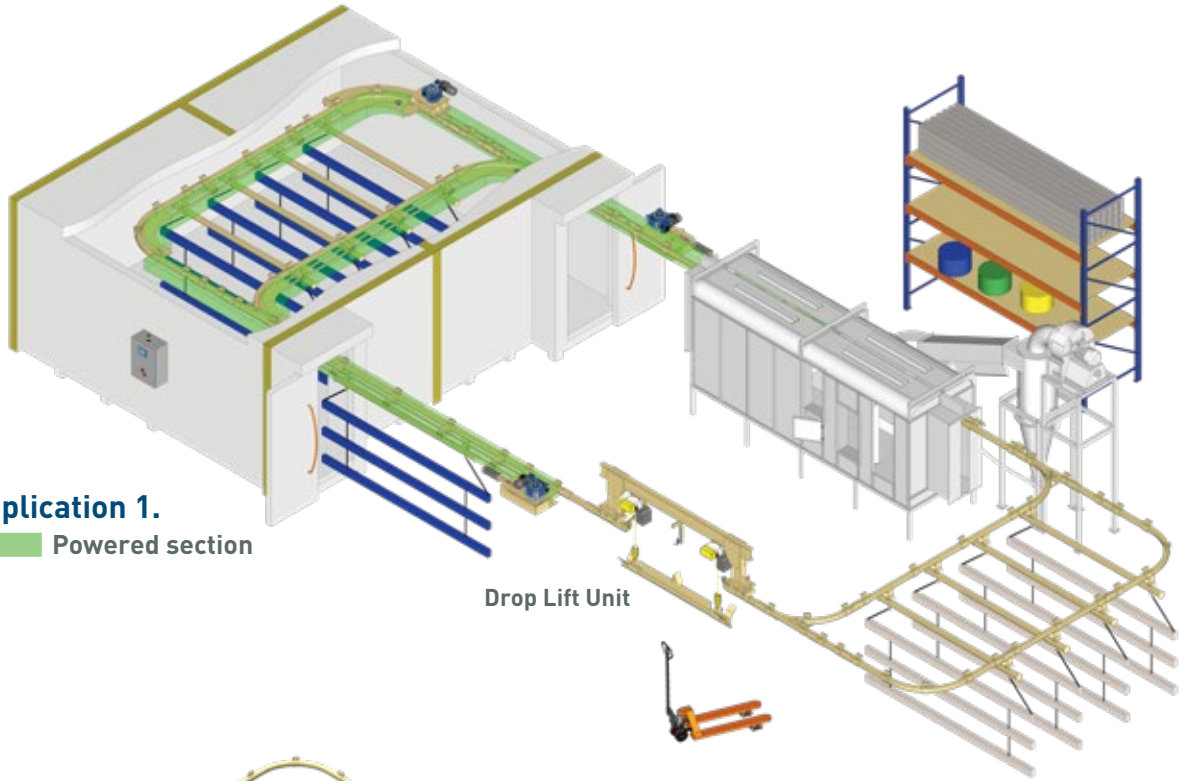

Application 1.

Powered section

Drop Lift Unit

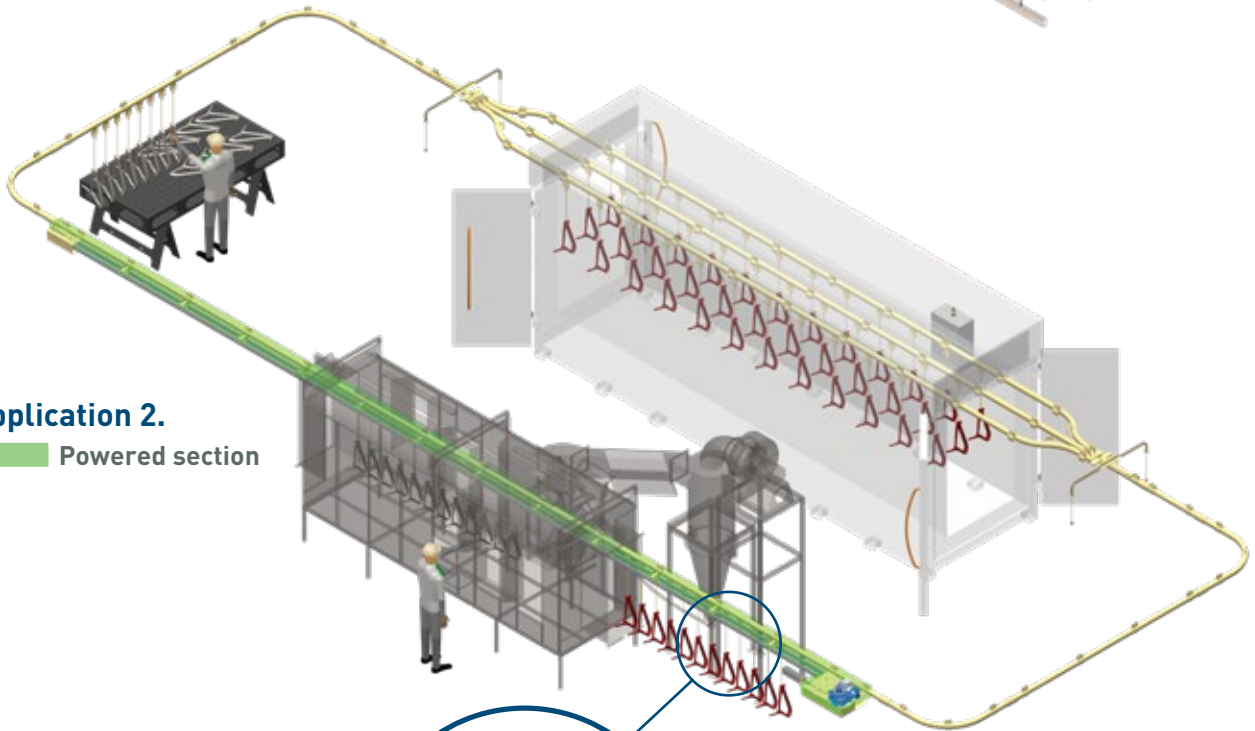

Application 2.

Powered section

Detail

Evaluation of NIKO conveyor systems: 3 case studies

The purpose of this case study is the evaluation of the power paint coating installations provided by the Greek company NIKO. NIKO company systems will be analysed and compared with systems commonly used in the industry, by highlighting the main parameters making the customer investment advantageous. The evaluation will be based on the following criteria:

A. System Productivity

The number of products painted by the painting line per operation day.

B. Human resources costs

A minimum number of employees is required for the correct operation of the system. The average cost per operation day (2 shifts) and per operator, has been evaluated at 140 €.

C. Installation Housing Costs*

The industrial space required for the installation of the system. The cost per square meter of the system is evaluated at 3€ and the operation days of the system at 22 per month.

D. Total cost of equipment*

The total cost of equipment is referred to the following costs: curing oven, painting booth, drying oven, washing room and the cost of the conveyor system.

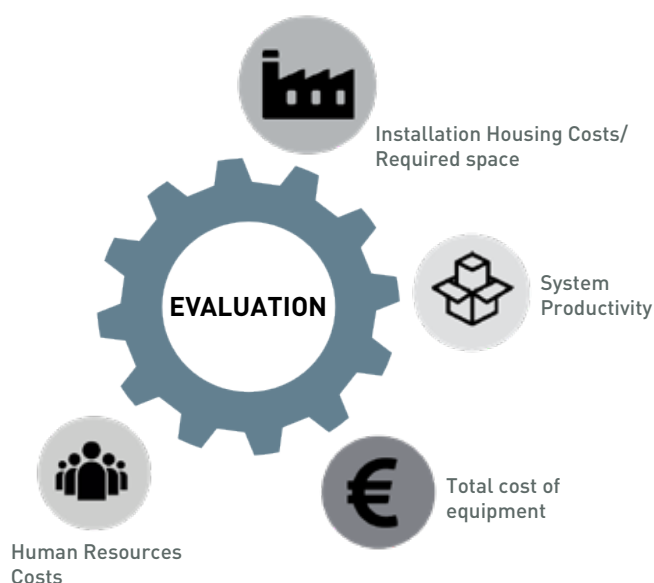

Process

Loading Procedure:

The components are loaded onto the conveyor system of the painting line.

Cleaning Procedure - Preparation:

The components are chemically cleaned for the removal of possible corrosion, lubricants and any residues of previous processing. The cleaning procedure is essential prior to the powder paint coating.

Drying Procedure: Following the chemical cleaning and the surface activation of the material, the painting line continues with the drying of the components. The duration of the drying procedure is 7 minutes at an oven temperature of 80°C.

Powder Paint Coating Procedure: The powder paint is applied to metal parts (aluminium profiles, metal frames, casting parts etc.) using special spray guns. The spray gun positively charges the powder particles, causing repulsion between them, resulting in the even spreading of paint using compressed air. The parts are earthed, attracting the powder particles and ensuring an more even coat of paint, in comparison to wet paint methods.

Curing Procedure: The painting line continues with the hardening of the powder paint coat. The components are exposed to an oven temperature of 180°-200°C, for approximately 20 minutes, allowing the powder paint to develop into an even dry protective film.

Unloading Procedure: The components are removed from the curing oven, are unloaded from the conveyor system and are made available for quality control and packaging.

* For this version the costs have been removed from comparisons in case studies 1,3.

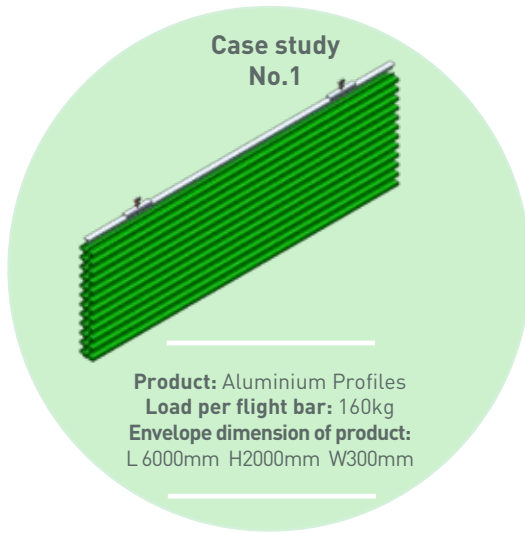

A TYPICAL SOLUTION

Continuous running conveyor

ALUMINIUM PROFILES

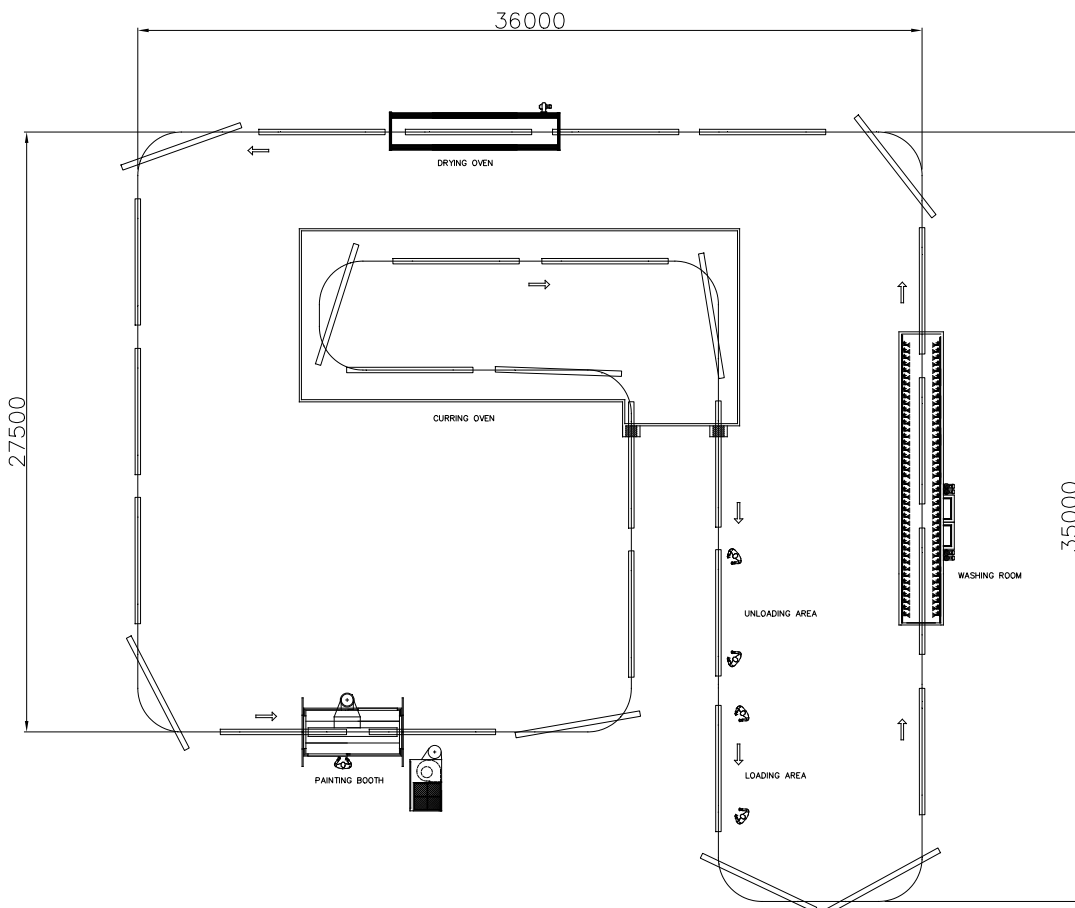

Required space:
11.850ft²



Operators: 5



Painting parts / day:
650 pieces

NIKO conveyor systems with batch shuttle and power chain conveyor

Track Profile 24.000

NIKO Conveyor is considerably more efficient providing:

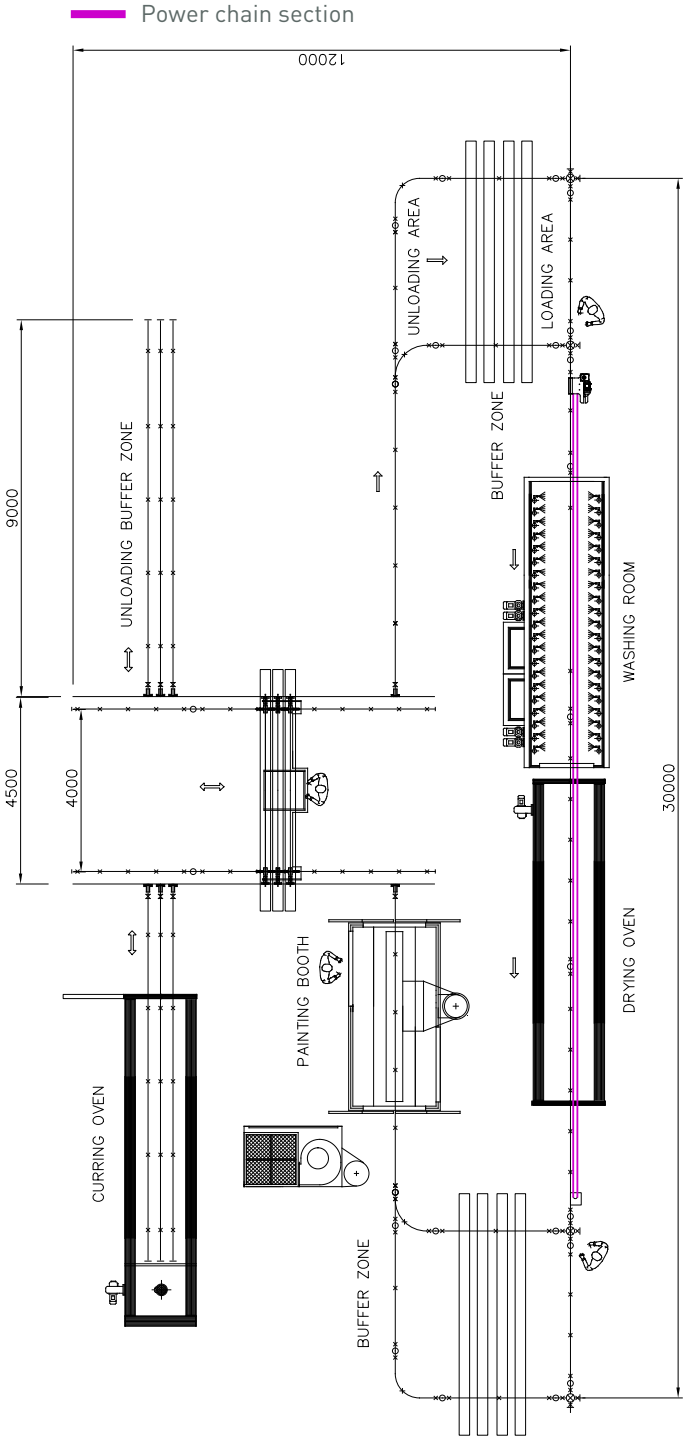

Required space: 3.875ft²



Operators: 4



Painting parts / day: 860 pieces

ALUMINIUM PROFILES

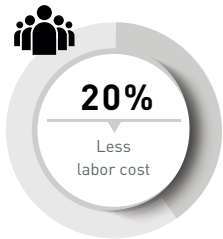
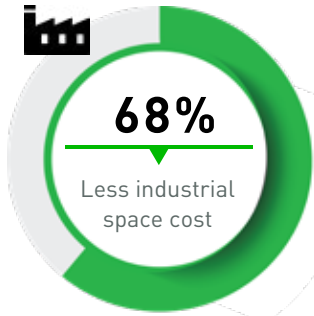



NIKO SOLUTION 2

NIKO conveyor systems with batch shuttle and power chain conveyor

Track Profile 24.000

NIKO Conveyor is considerably more efficient providing:

Power chain section

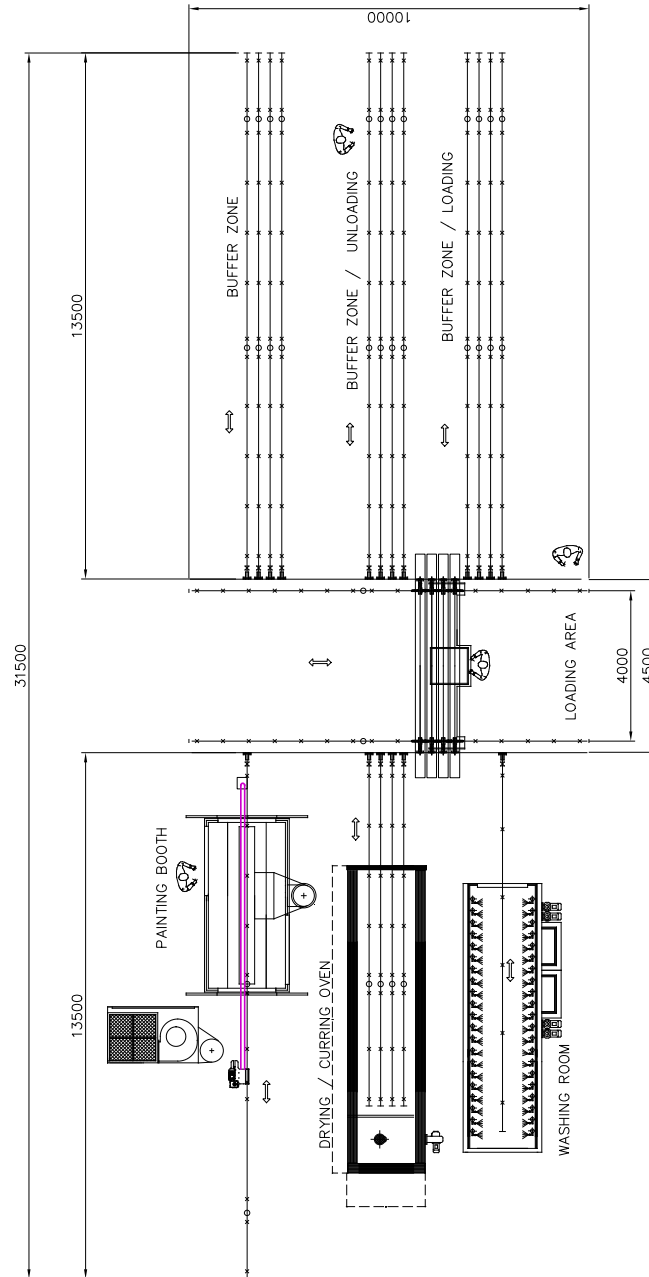

ALUMINIUM PROFILES

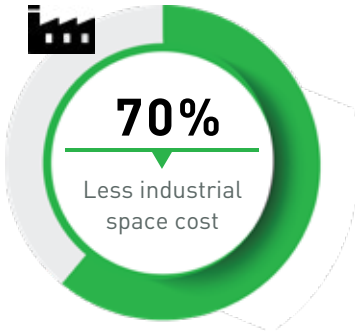

Required space: 3.390ft²



Operators: 4



Painting parts / day: 880 pieces

NIKO power chain conveyors

Track Profile 24.000

NIKO Conveyor is considerably more efficient providing:

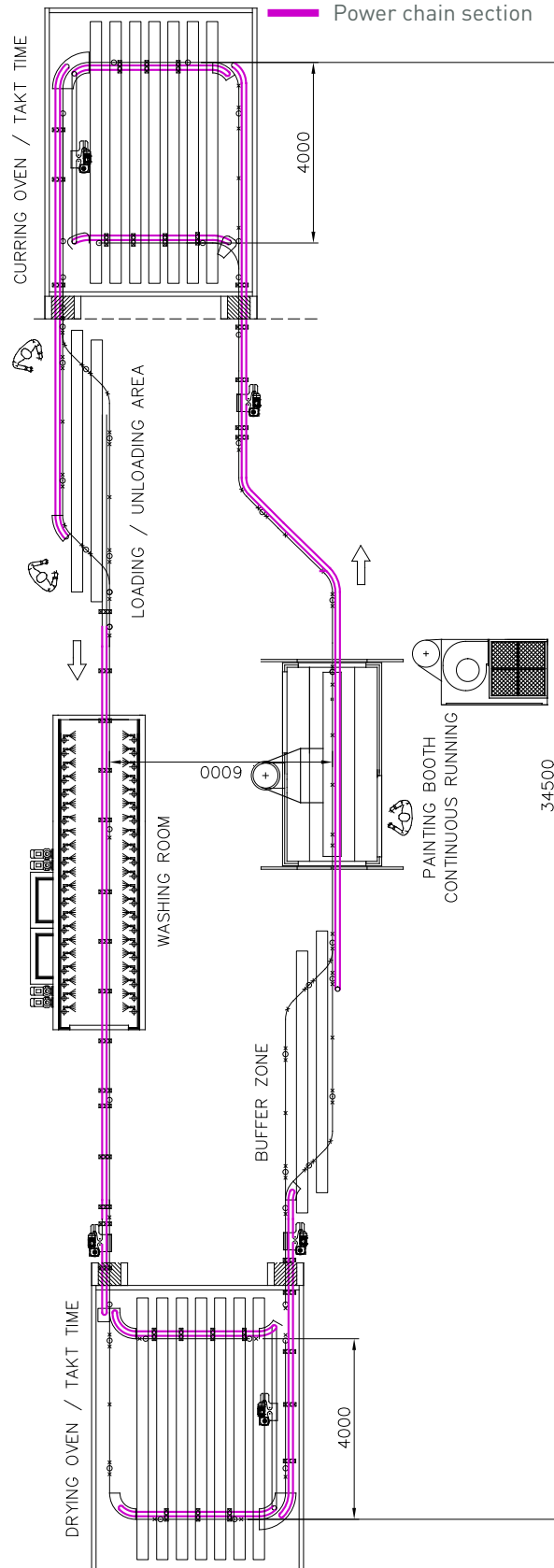

Required space: 4.305ft²



Operators: 3



Painting parts / day: 1.200 pieces

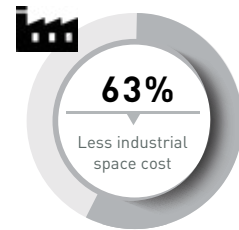

ALUMINIUM PROFILES

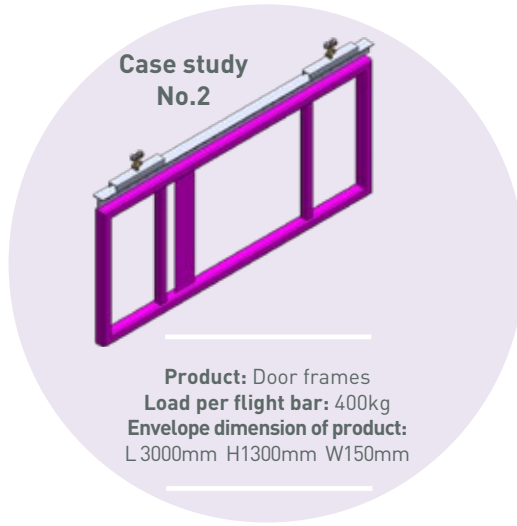

**A TYPICAL SOLUTION
 P & F
 conveyor system**

DOOR FRAMES

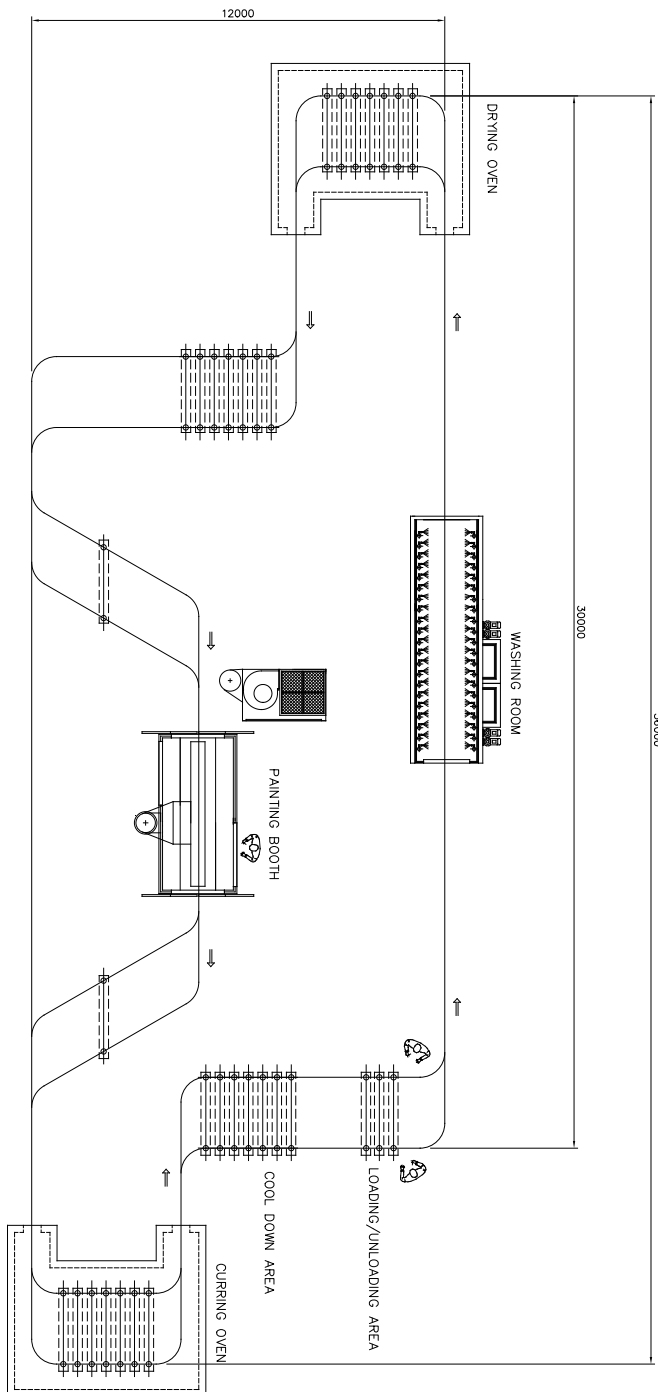

Total cost of conveyor:
120.000€



Total cost of equipment:
175.000€



Required space:
5.490ft²



Operators: 3



Painting parts / day:
185 pieces

NIKO power chain conveyors

Track Profile 25.000

NIKO Conveyor is considerably more profitable providing:

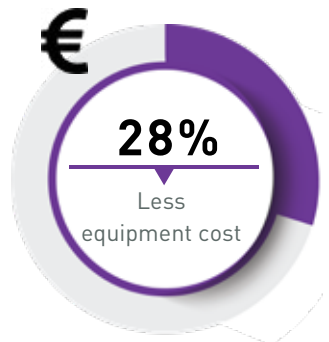
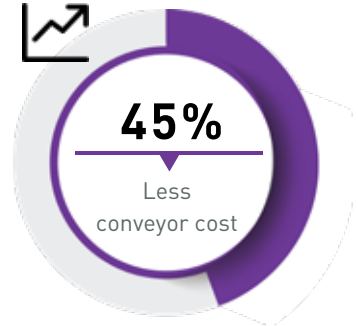

DOOR FRAMES

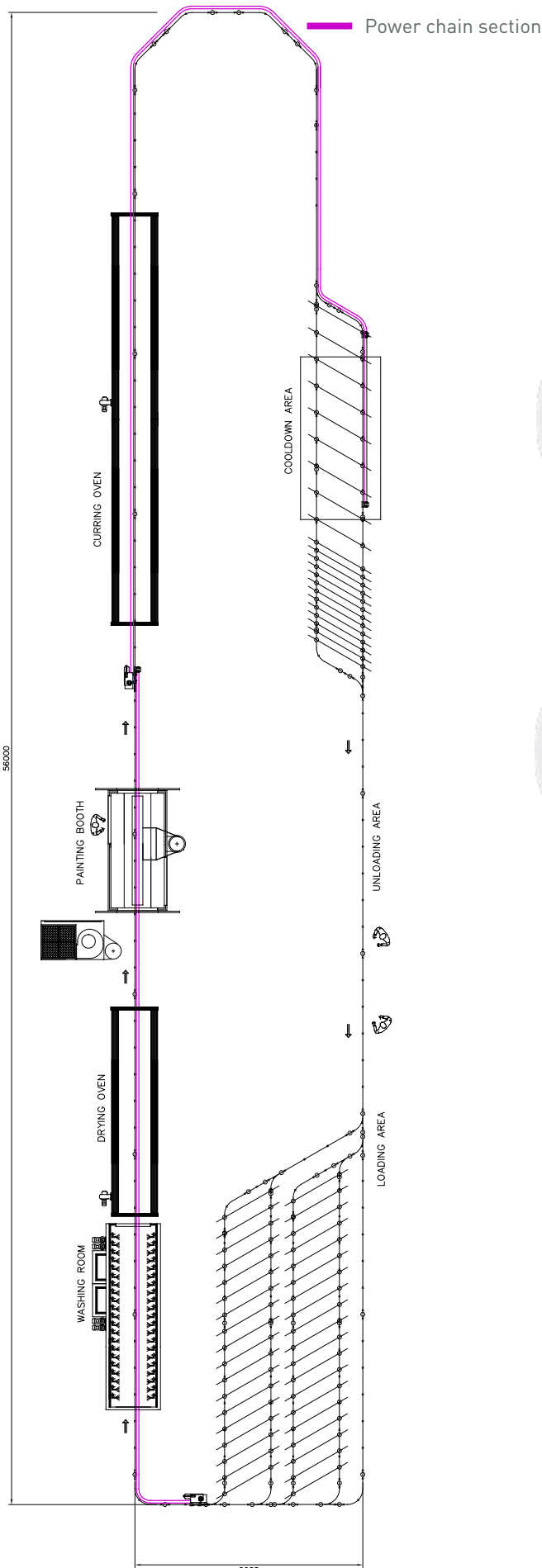

Total cost of conveyor:
65.000€



Total cost of equipment:
125.000€



Required space:
6.245ft²



Operators: 3



Painting parts / day:
160 pieces



NIKO SOLUTION 2

NIKO conveyor systems with batch shuttle

Track Profile 25.000

NIKO Conveyor is considerably more profitable providing:

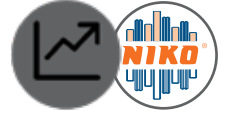

Total cost of conveyor: 22.000€



Total cost of equipment: 40.000€



Required space: 2.150ft²



Operators: 5



Painting parts / day: 90 pieces

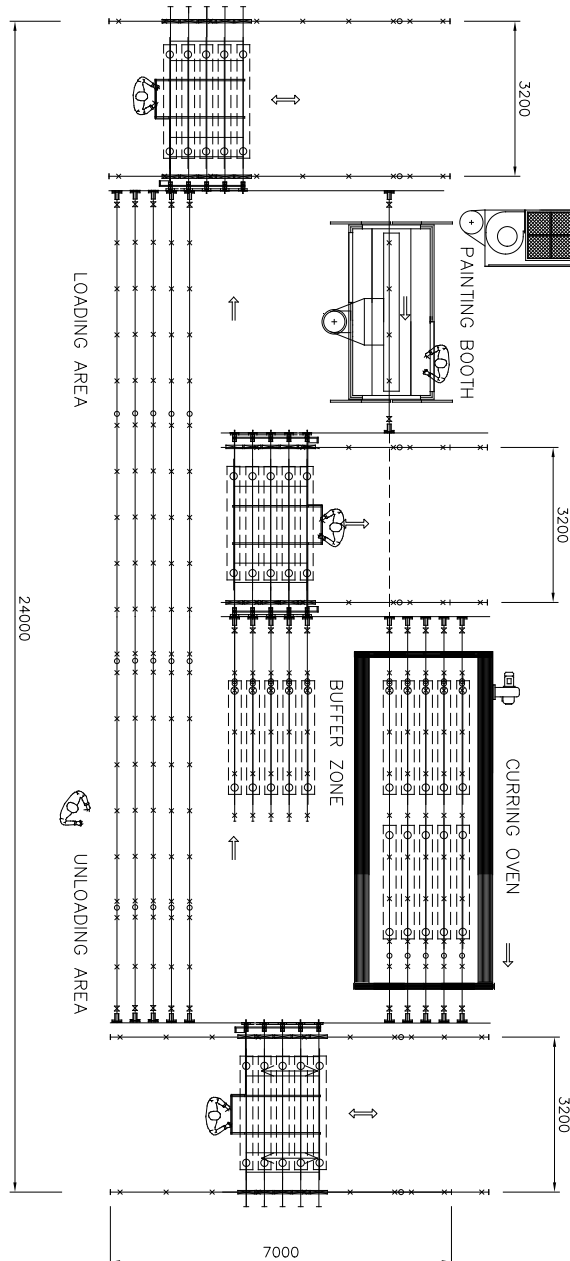
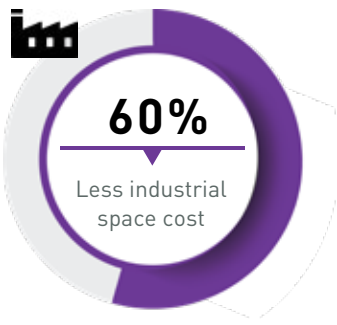
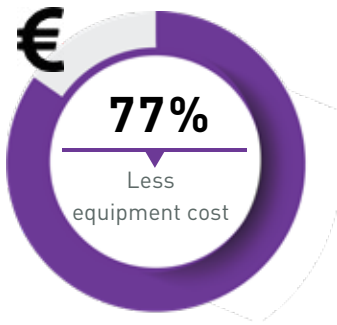
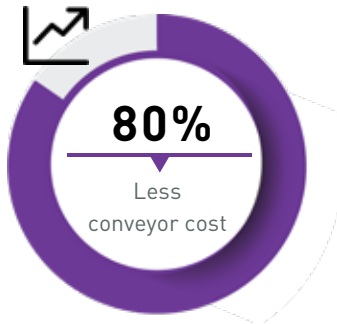

DOOR FRAMES

NIKO conveyor systems with power chain conveyor

NIKO SOLUTION 3



Track Profile 25.000

Power chain section

NIKO Conveyor is considerably more profitable providing:

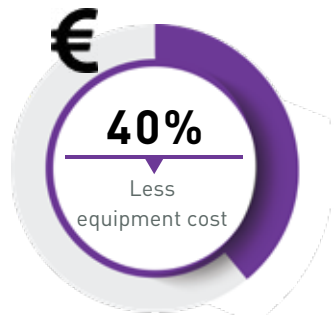
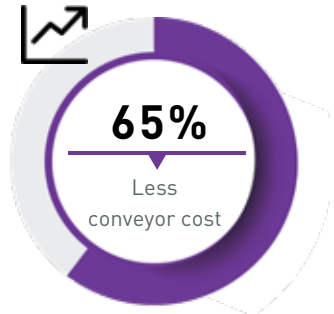

DOOR FRAMES

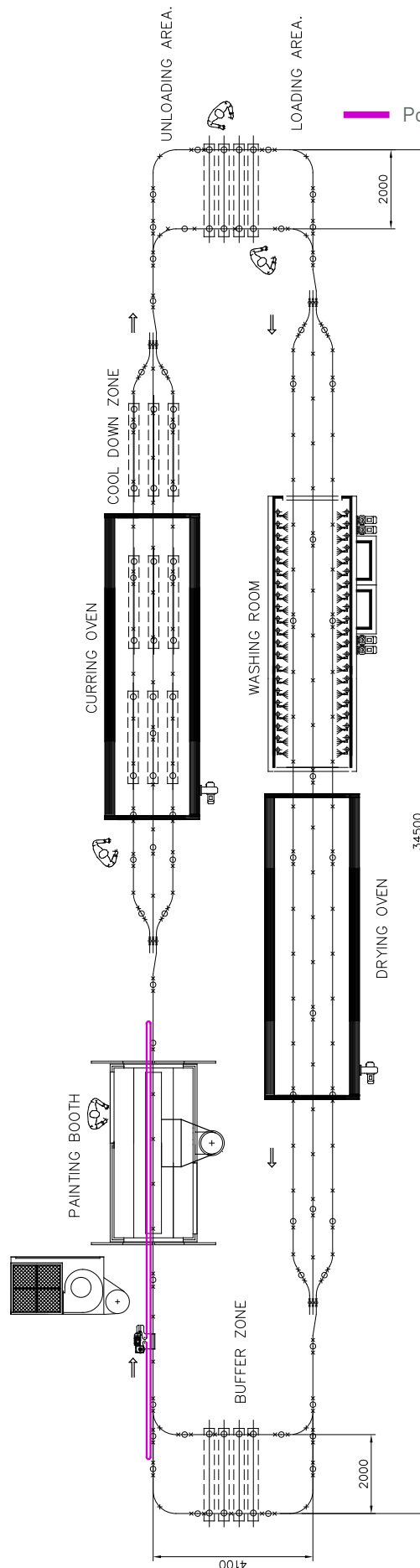

Total cost of conveyor: 41.000€



Total cost of equipment: 105.000€



Required space: 3.010ft²



Operators: 4



Painting parts / day: 110 pieces

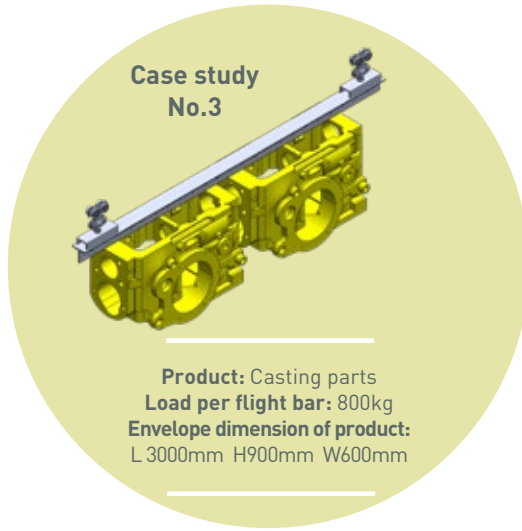

A TYPICAL SOLUTION

Painting line with forklift

CASTING PARTS

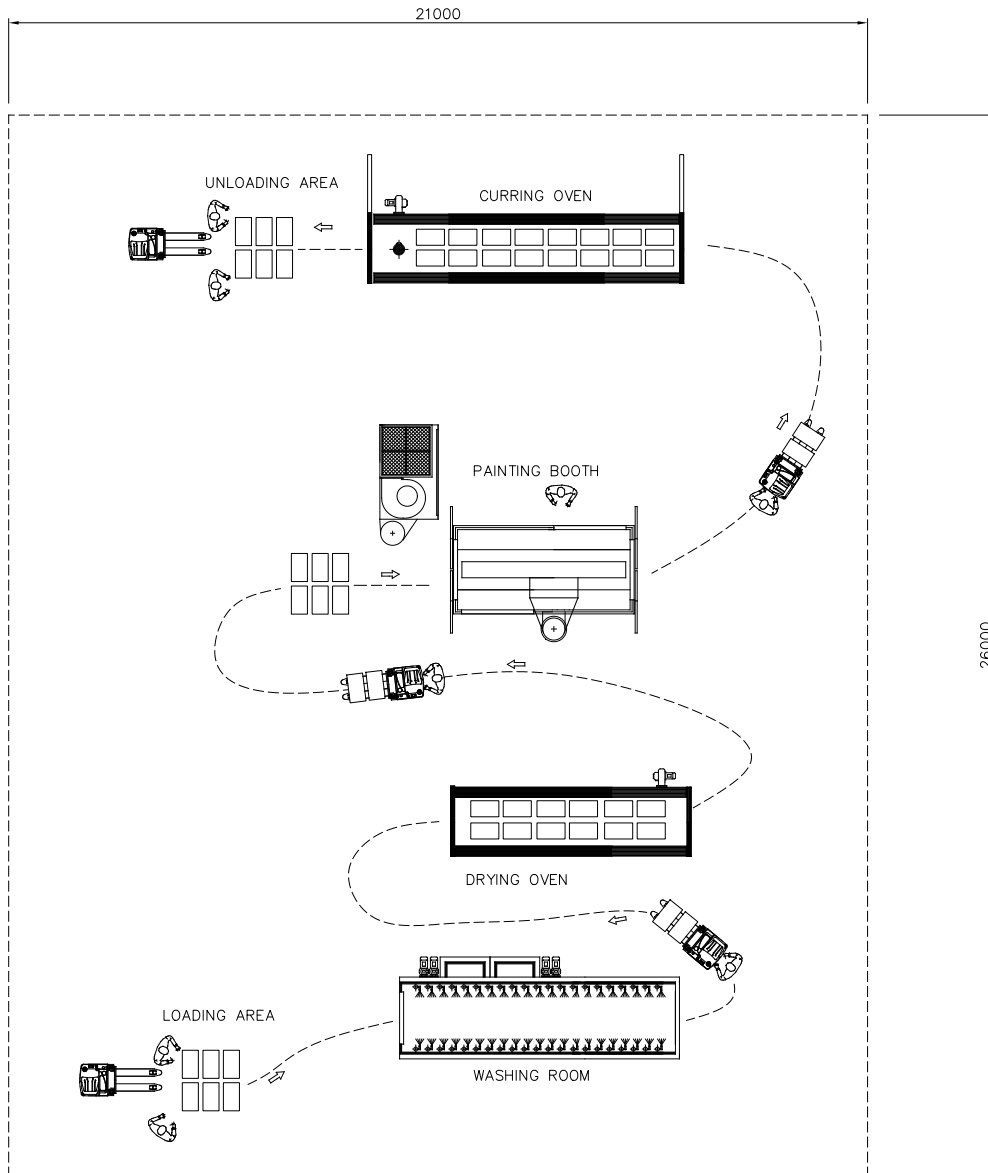

Required space:
5.810ft²



Operators: 8



Painting parts / day:
85 pieces

NIKO conveyor systems with power chain conveyor

NIKO SOLUTION 1



Track Profile 26.000

NIKO Conveyor is considerably more efficient providing:

Power chain section

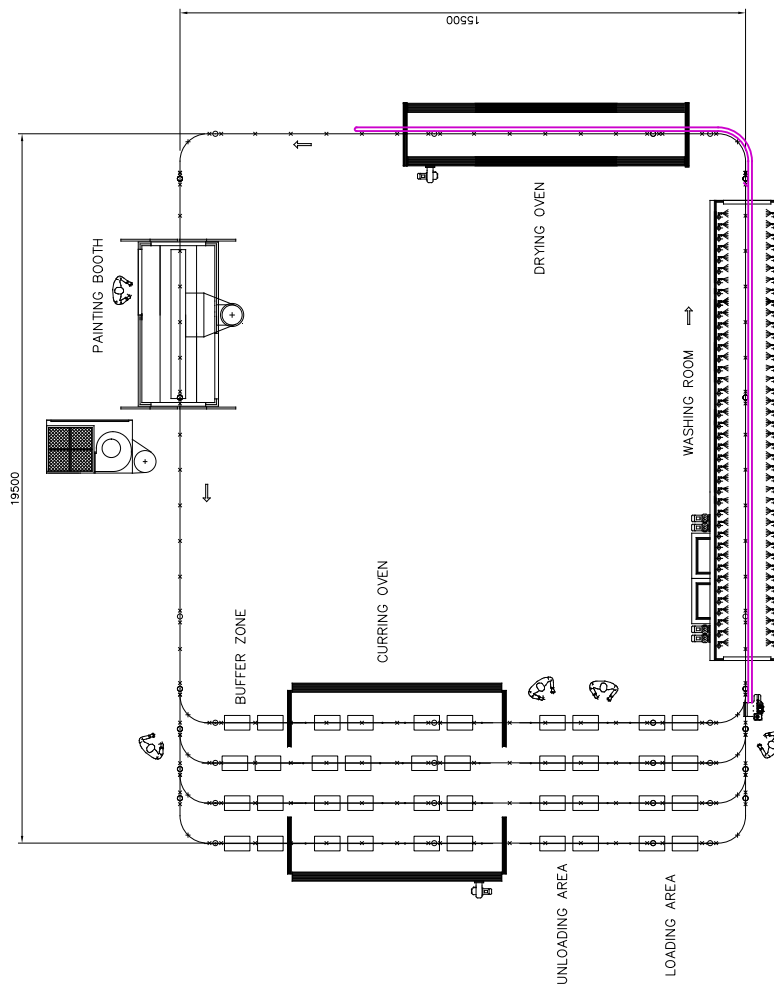

Required space:
3.330ft²



Operators: 5



Painting parts / day:
170 pieces

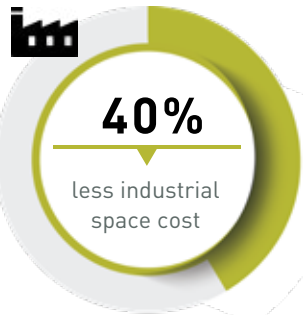

CASTING PARTS



NIKO SOLUTION 2

NIKO conveyor systems with batch shuttle and power chain conveyor

Track Profile 26.000

NIKO Conveyor is considerably more efficient providing:

Power chain section

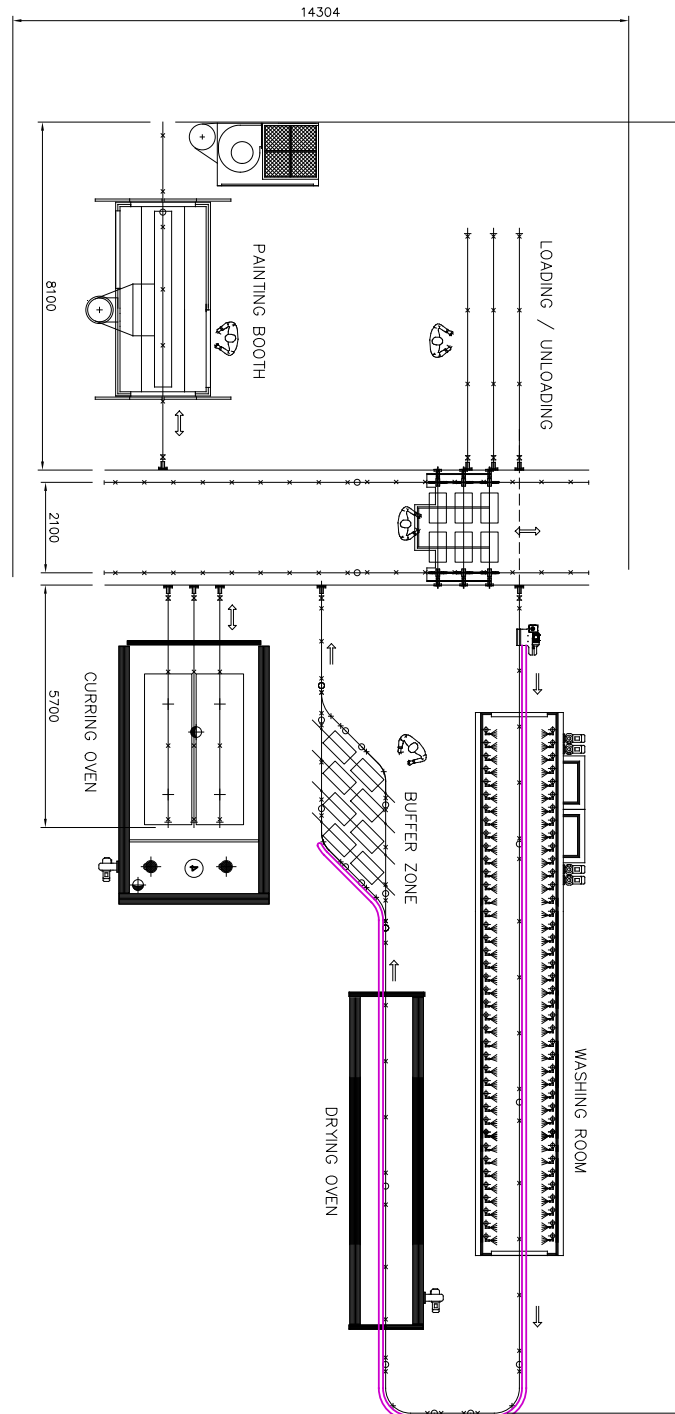

CASTING PARTS

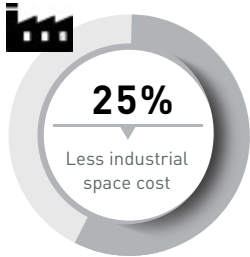

Required space: 4.305ft²



Operators: 4



Painting parts / day: 210 pieces

NIKO power chain conveyors

Track Profile 26.000

NIKO Conveyor is considerably more efficient providing:

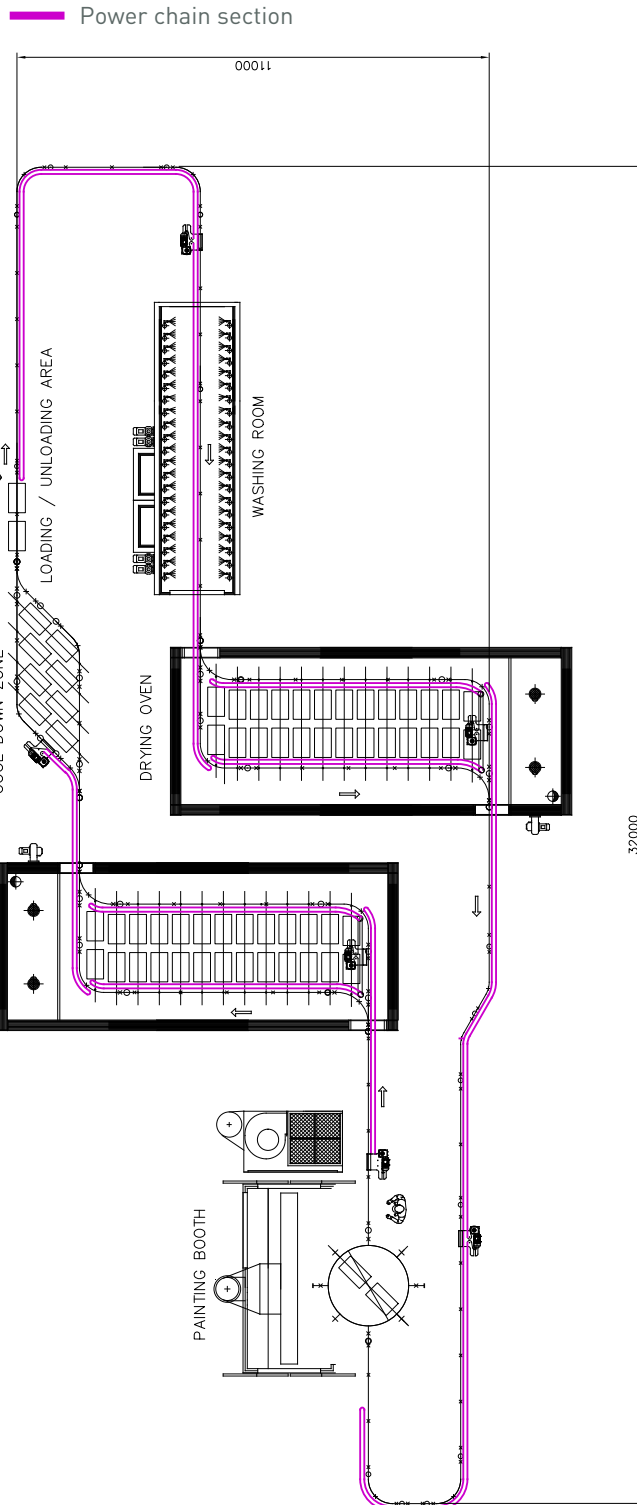

Required space: 3.980ft²



Operators: 3



Painting parts / day: 620 pieces

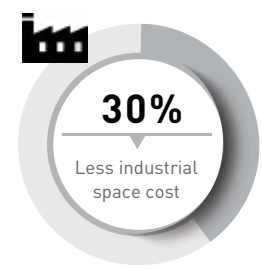

CASTING PARTS



Transforming your Conveying Needs into Systems that Deliver a Cost Effective Solution

AUSTRIA-NIKO Vertriebs GmbH

Hainfelder Straße 48
 A - 2560 Berndorf
 Tel. 0043 2672-21201
 Fax 0043 2672-21201-13
 office.at@niko.eu.com
www.niko.world

CANADA - NIKO Crane Canada

615, rue du Nickel
 Québec (Québec) G2N 0J9
 Tel. 418 841.2287
 info@smakdesign.ca
www.smakmanutention.com

CHINA-NIKO TRADING (SHANGHAI) Co., Ltd

Room 605, Building #13, No.354
 Linghe Road, Pudong District,
 P.R.China - 200120 Shanghai
 Tel. 0086 139 1814 5645
info.cn@niko.eu.com

USA Light Crane Systems- NIKORAIL

8000 Joliet Rd.
 McCook, IL 60525
 Toll Free 888.352.1213
 Tel. 001 708-352-1213
sales@hsicrane.com
www.nikorail.com

GERMANY-NIKO Technik GmbH

Robert-Bosch-Str. 14
 DE - 42489 Wülfrath
 Tel. 0049 (0) 2058 9093603
 Fax 0049 (0) 2058 9093604
office.de@niko.eu.com

GREECE-Helm Hellas S.A.

82nd Km Athens-Korinthos
 P.O. Box 209
 GR - 201 00 KORINTHOS
 Tel. 0030 27410 76800
 Fax 0030 27410 25368
info@niko.eu.com

POLAND- NIKO Polska

Wojska Polskiego 65A
 PL - Wielun 98-300
 Tel. 0048 504 00 35 56
info.pl@niko.eu.com

UNITED KINGDOM-NIKO Ltd.

Airfield Park Business Park
 Welsh Road East, Southam
 Warwickshire, CV47 1NE
 Tel. 0044 (0) 1926 813111
 Fax 0044 (0) 1926 815599
Sales@niko.co.uk
www.niko.co.uk

USA-NikoTrack LLC

210 Century Drive
 Bristol, CT 06010
 Tel. 001 860-845-8179
 Fax 001 860-584-8612
info@nikotrack.com
www.nikotrack.com

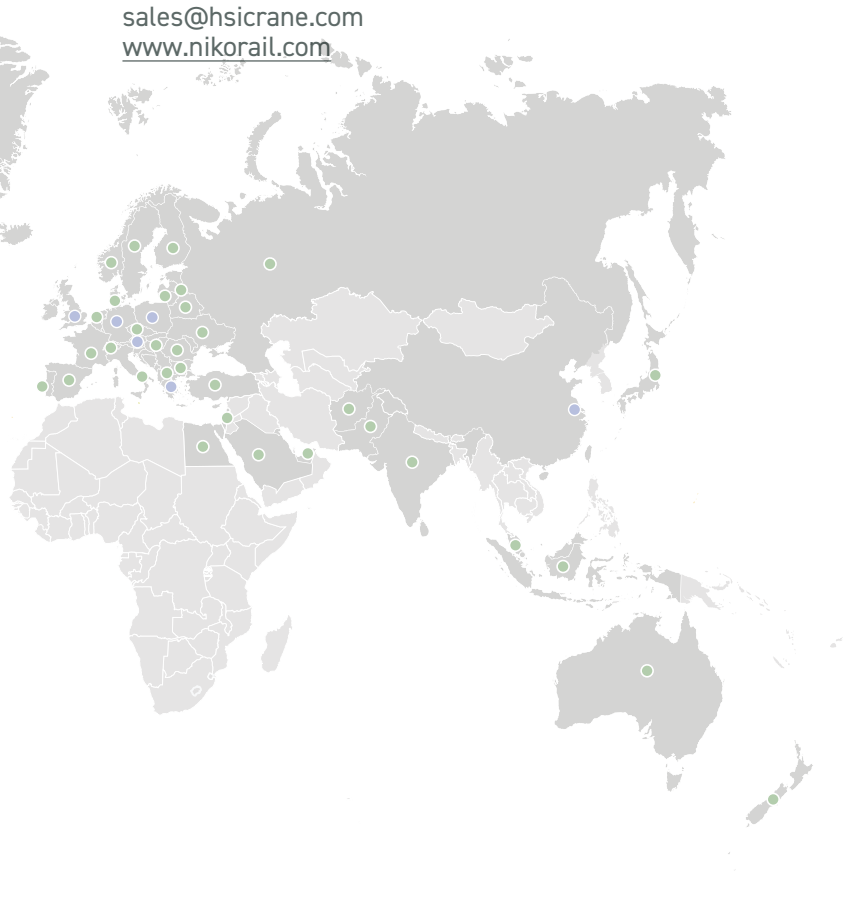

SmakHandling.com
1.844.841.2288



We take no obligation for layout, composition, technical modifications or misprints.
 Subject to technical modifications / Images may differ from actual products.